

MDP FTV

Mini DisplayPort connection system for harsh environment



Description

MDPFTV is a complete ruggedized solution around Mini DisplayPort standard using a Tri Start Thread coupling mechanism (MIL-DTL-38999 series III type) to connect the two plug and receptacle parts.

This solution allows you to insert a standard Mini DP cordset into a metallic plug which will protect it from shocks, dust and fluids. The assembly of this ruggedized plug doesn't require any tool and can be easily done directly on the field.

The corresponding MDP FTV receptacle dedicated to be mounted on your panel enables you to reinforce and protect your system against leakage, shocks, vibrations and much more.

Main features

Main characteristics :

- Tri Start Thread coupling mechanism (MIL-DTL-38999 series III type) with anti-decoupling device.
- Shell size 13.
- No cabling operation in field and no tools required.
- Improved EMI protection.
- Mating cycles : 500 min.
- Panel thickness : 1,6 mm min and 3,18 mm max for jam nut receptacle.

Data Transmission :

- Display 1.4 protocol.
- Transmission bandwidth : 32.4 Gbit/s with 8.1 Gbit/s per lane.
- Can support 8K UHD (7680 × 4320) at 60 Hz or 4K UHD (3840 × 2160) at 120 Hz.

Environmental protection :

- Sealed against fluids and dusts : IP68 mated.
- Salt spray : Aluminium shell : Nickel plating ✓ : 48h.
Black zinc nickel plating ✓ : 500h.
Olive drab cadmium plating : 500h

Fire retardant/Low smoke : EN45545 + UL94V0.

Vibrations : 10 - 500 Hz, 10 g, 3 axes : no discontinuity > 10 micro s.

Shocks: IK06 ► weight of 250 g drop from 40 cm [15.75 in]. onto connectors (mated pair).

Humidity : 21 days, 43°C, 98% humidity.

Temperature range : -40°C / +85°C.

✓ : RoHS compliant

Markets & Applications



C4ISR, Battlefield,
Ground vehicles



Navy



Railway



Applications :

- Data acquisition and transmission in harsh environment, radars, shelters, battlefield communication

Plug without cordset - Shell type 6

Part number type: **MDP FTV 6 XX**

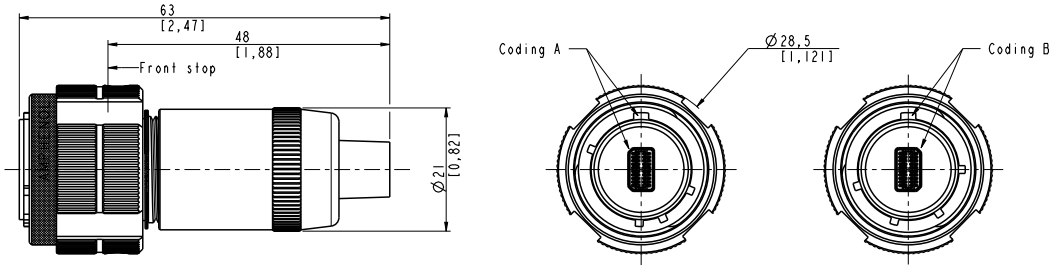

MiniDP plug recommendation dimensions (not included)

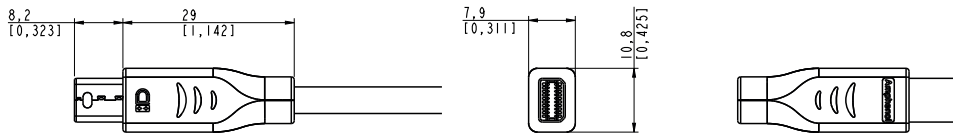

Receptacles

Reduced flange Jam nut receptacle – Shell type 7 - Castle nut mounting: Deviation F312

Part number type: **MDP FTV 7 XX F312**

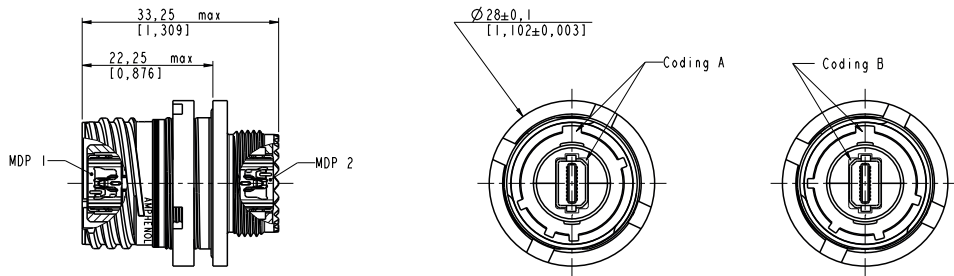

Panel drilling

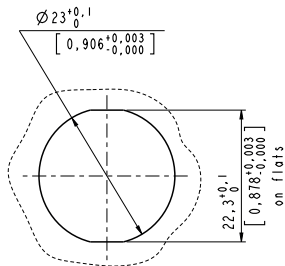

MiniDP plug recommendation dimensions (not included)

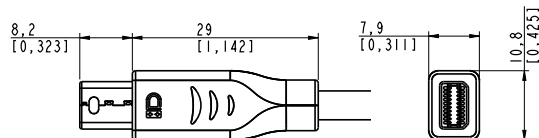

X: see the 'How to order' below to complete your part number

Receptacles

Reduced flange Jam nut receptacle – Shell type 7PE with metal backshell - Castle nut mounting: Deviation F312

Part number type: **MDP FTV 7 X PE X F312**

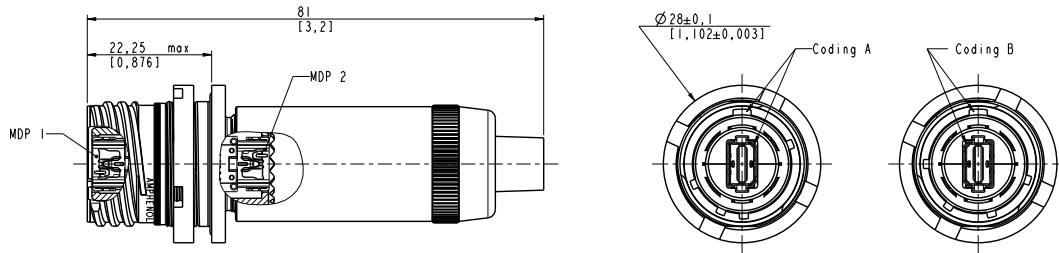

Panel drilling

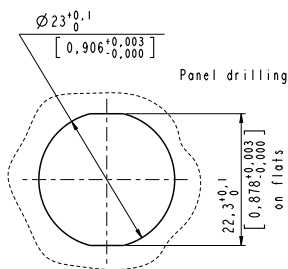

MiniDP plug recommendation dimensions (not included)

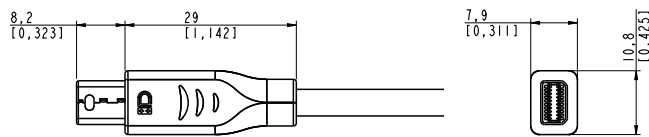

Cordsets

MiniDisplay Port - MiniDisplay Port cordset

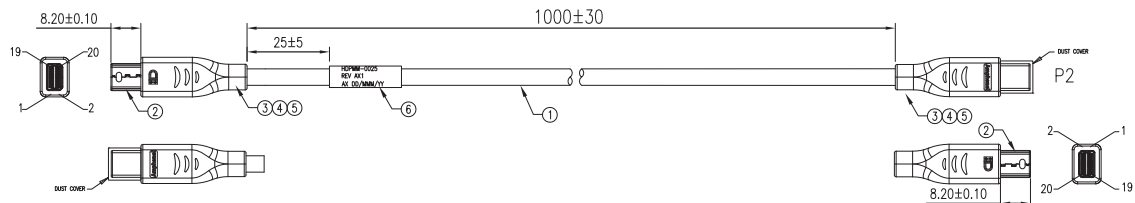

MiniDisplay Port – Display Port cordset

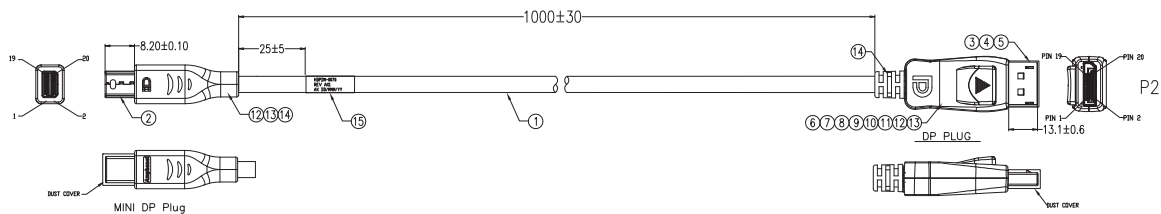

MiniDisplay Port – Female Display Port cordset

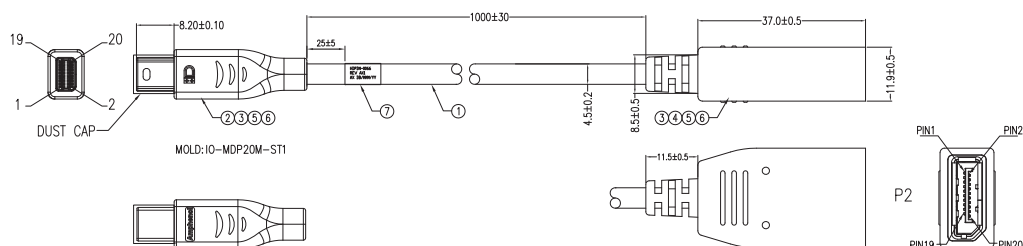

X: see the 'How to order' below to complete your part number

Accessories

Standard protective cap

Part number: **MDPF_{TV} C 6 X**

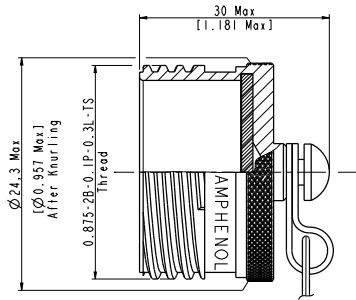

Tie wrap for plug cap



Part number: **MDPF_{TV} C 2 X or MDPFTV C 7 X**

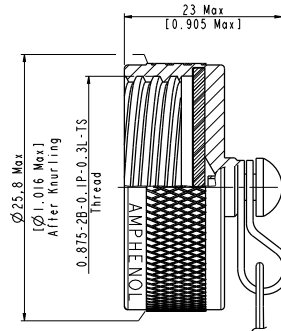

Ring for reduced flange jam nut receptacle

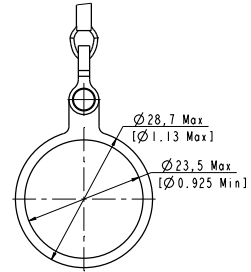

Metallic chain



Stainless steel rope

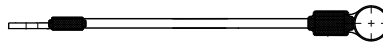

Nylon rope

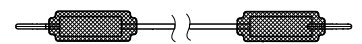

Cap type	Metallic chain length (mm)	Nylon cord length (mm)	Stainless steel rope length (mm)
MDPF_{TV} C 2 & MDPFTV C 7		127 (+13,-7)	
MDPF_{TV} C 6		160±5	

X: see the 'How to order' below to complete your part number



NOTES

A series of horizontal dotted lines spanning the width of the page, providing a template for handwritten notes.

How to order - Connector

1.	2.	3.	4.	5.	6.
Series	Shell type	Coding	Backshell	Material and platings	Deviation
MDP FTV	7	A	PE	G	F312

1. Series

MDP FTV MiniDisplay Port

4. Backshell (for receptacle only)

PE Metal backshell

2. Shell type

6 Plug
7 Jam nut receptacle

5. Material and platings

	Shell material	Shell finish
G	Aluminum	Olive drab cadmium
N		Nickel ✓
ZN		Black zinc nickel ✓

3. Coding

A Coding A
B Coding B

6. Deviation (for receptacle only)

F312 Reduced flange receptacle

How to order - Cordset

1.	2.	3.
Series	Cordset end	Coding
MDP	MDP	100

1. Series

MDP MiniDisplay Port

3. Length

100 1 m
150 1,50 m
200 2 m

2. Cordset end

MDP Plug
DP Display Port
DPF Female Display Port

How to order - Accessories

1.	2.	3.	4.	5.
Series	Connector type	Rope type	Shells material and finish	Deviation
MDPFTV C	7		G	F057

1. Series

MDPFTV C MDPFTV standard protective cap

4. Shell material and finish

N	Nickel plating ✓
G	Olive drab cadmium
ZN	Black zinc nickel plating ✓

2. Connector type

6 Plug
7 Jam nut receptacle

5. Deviation

F057 Reduced flange ring

3. Rope type

Nylon cord
M Metallic chain
MR Stainless Steel rope - Transparent teflon jacket
BMR Stainless Steel rope - Black teflon jacket